



# White paper

Protection of cell sites (4G / LTE)



## Contents

- Cell sites with remote radio heads/units
- Design of radio base stations (RBS) with DEHNvap CSP combined arresters, design of remote radio head applications
- Customised solutions with type 1 or 2 arresters
- DEHNsecure 60 ..., modular type 1 lightning current arresters
- Type 1 combined arresters
- Comparison of the protective effect of spark-gap-based and varistor-based type 1 arresters

# White paper

## Protection of mobile cell sites (4G / LTE)

With the commercial introduction of UMTS technology in 2003, mobile data communication gained in importance besides voice communication. As the demand for data volumes grew, so did the global demand for bandwidth.

The increasing use of smartphones and other mobile terminal equipment leads to a significantly higher utilisation of existing conventional mobile networks.

The motivation for mobile network operators to rely on modern and innovative technology are the high investment costs for new network infrastructures and system technology as well as high maintenance and operating costs for existing cell sites. Their aim is to efficiently reduce maintenance and operating costs and to considerably increase the availability and reliability of cell sites for an ever growing number of mobile phone users.

Mobile network operators and system technology manufacturers worldwide increasingly use remote radio head/unit technology for UMTS (3G) and LTE (4G). Remote radio heads/units (RRHs/RRUs) are a refinement of the third mobile radio generation.

Remote radio head technology is not only used for commercial mobile radio applications, but also for the digital radio systems of security authorities (BOS) such as police and emergency medical services since these systems require high reliability and availability.

### Conventional cell sites

Conventional cell sites use coaxial cables, also referred to as waveguide cables. A clear disadvantage of this technology

is the high transmission loss (up to 50%), depending on the cable length and cable cross-sections of the high-frequency cables. Moreover, the complete radio transmission technology is integrated in the base station/radio base station (RBS). This requires permanent cooling of the technical rooms and leads to increased energy consumption and maintenance costs (Figure 1).

### Cell sites with remote radio heads/units

Remote radio heads/units incorporate the high-frequency technology which was originally integrated centrally in the base station. The high-frequency signal is directly generated at the antenna and is then transmitted. Therefore, the RRHs/RRUs are installed directly at the antennas, thus reducing loss and increasing the transmission speed. Another benefit is that less air-conditioning systems are required due to the self-cooling of the remote radio heads. Optical fibre cables allow to transmit data between the base station/radio base station and the remote radio heads/units up to 20 km. The use of remote system technology and modern small-sized base stations saves energy costs as well as lease and location-related costs due to the reduced number of technical rooms (Figure 1).

### External lightning protection

The antennas of the before mentioned systems are often installed on rented roof space. The operator of the antennas and the building owner usually agree that the placement of the antennas must not present an additional risk for the building. This means for the lightning protection system that no partial

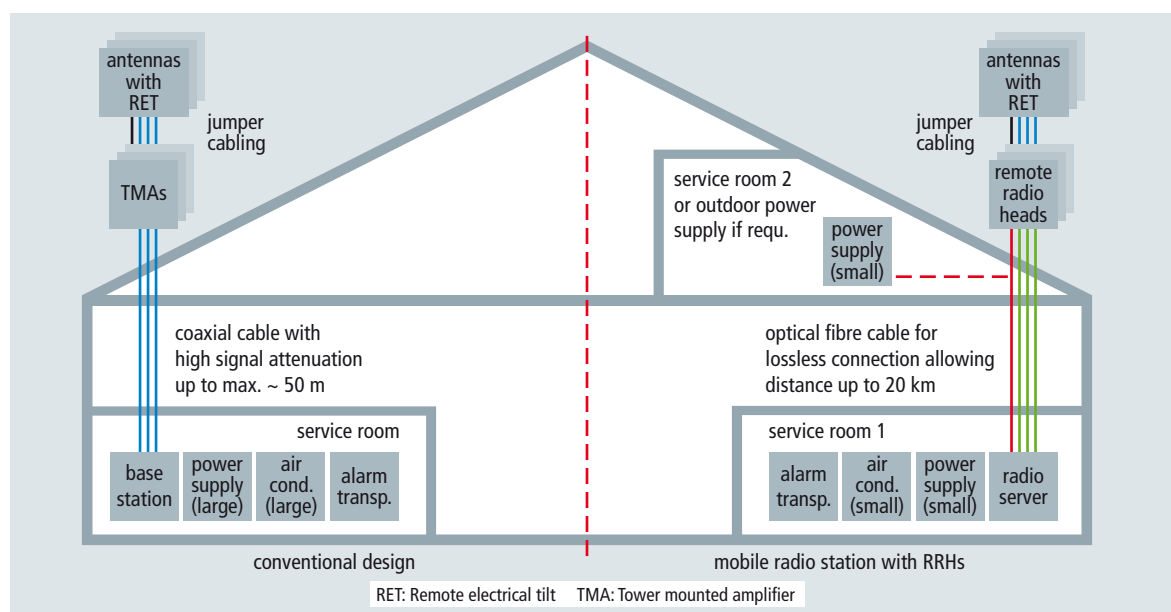

Figure 1 Comparison: Conventional cell site (left) and cell site with remote radio head technology (right)



lightning currents may enter the building in case of a lightning strike in the radio tower to prevent electric and electronic devices from being damaged or even destroyed.

Figures 2 and 3 show radio towers with isolated air-termination systems.

The air-termination tip must be insulated when attached to the radio tower by means of a supporting tube made of non-conductive material. The height of the air-termination tip depends on the radio tower and possible electrical equipment of the antenna system and radio base station (RBS) to integrate them into the protected zone of the air-termination system. In case of buildings with several antenna systems, several isolated air-termination systems must be installed.

#### Design of radio base stations (RBS) with DEHNvap CSP combined arresters

The power supply unit of the RBS must have a separate feeder cable that is independent from the power supply unit of the building. Cell sites must be supplied by a separate sub-distribution board / floor distributor. Every sub-distribution board is equipped with type 1 combined arresters as standard. In addition, a type 2 combined arrester is installed downstream of the meter, namely downstream of the fuses. To ensure energy coordination, surge protective devices (SPDs) from the same manufacturer should be used at both places of installation. Extensive laboratory tests at DEHN + SÖHNE with power supply units from different manufacturers confirm that coordination of combined arresters such as DEHNvap CSP (CSP = Cell Site Protection) with the integrated input circuits of the power supply unit is essential.

DEHNvap CSP 3P 100 FM spark-gap-based combined arresters are used to protect the power supply unit (PSU) of a base station. These type 1 arresters are specifically designed for protecting power supply units in radio transceivers.

When using combined arresters, "disconnection selectivity" with respect to upstream fuses must be ensured. Only sufficient follow current extinction and limitation allow to avoid false tripping of system fuses and thus disconnection of the power supply unit.

#### Design of remote radio head/unit applications

Cell sites consist of:

- ➔ Base station/radio base station (indoor or outdoor cabinet)
- ➔ Baseband unit/radio server
- ➔ Remote radio heads/units (RRHs/RRUs)

The remote radio heads/units (active system technology) require a separate 48 V d.c. voltage supply from the service room. To this end, shielded multi-wire copper cables with a cross-section of 6 to 16 mm<sup>2</sup> are typically used. In the majority of cases, these d.c. cables are installed outside the building

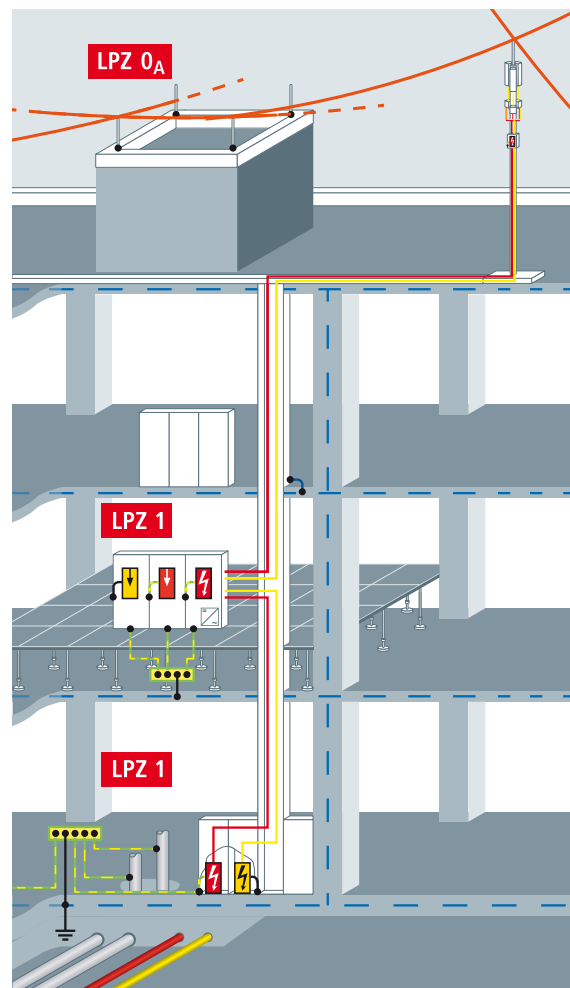

Figure 2 Basic design of the remote radio head/unit in case of a roof-mounted system

up to the roof surface and the RRHs/RRUs or from the base station to the mast. Data communication between RRHs/RRUs and system technology is done via prewired glass fibre cables instead of the previously used cables with corrugated sheath. The d.c. feeder cables and system technology are exposed to lightning currents in case of a direct lightning strike.

Thus, lightning current and surge arresters must be capable of safely conducting lightning currents to the earth-termination system. To this end, lightning current arresters classified as type 1 SPDs in conformity with EN 61643-11 (class I, IEC 61643-1/-11) are used. Only spark-gap-based type 1 arresters ensure reliable energy coordination with downstream protective circuits integrated in the input of terminal equipment. If spark gaps are used for protecting base stations,

# White paper

## Protection of mobile cell sites (4G / LTE)

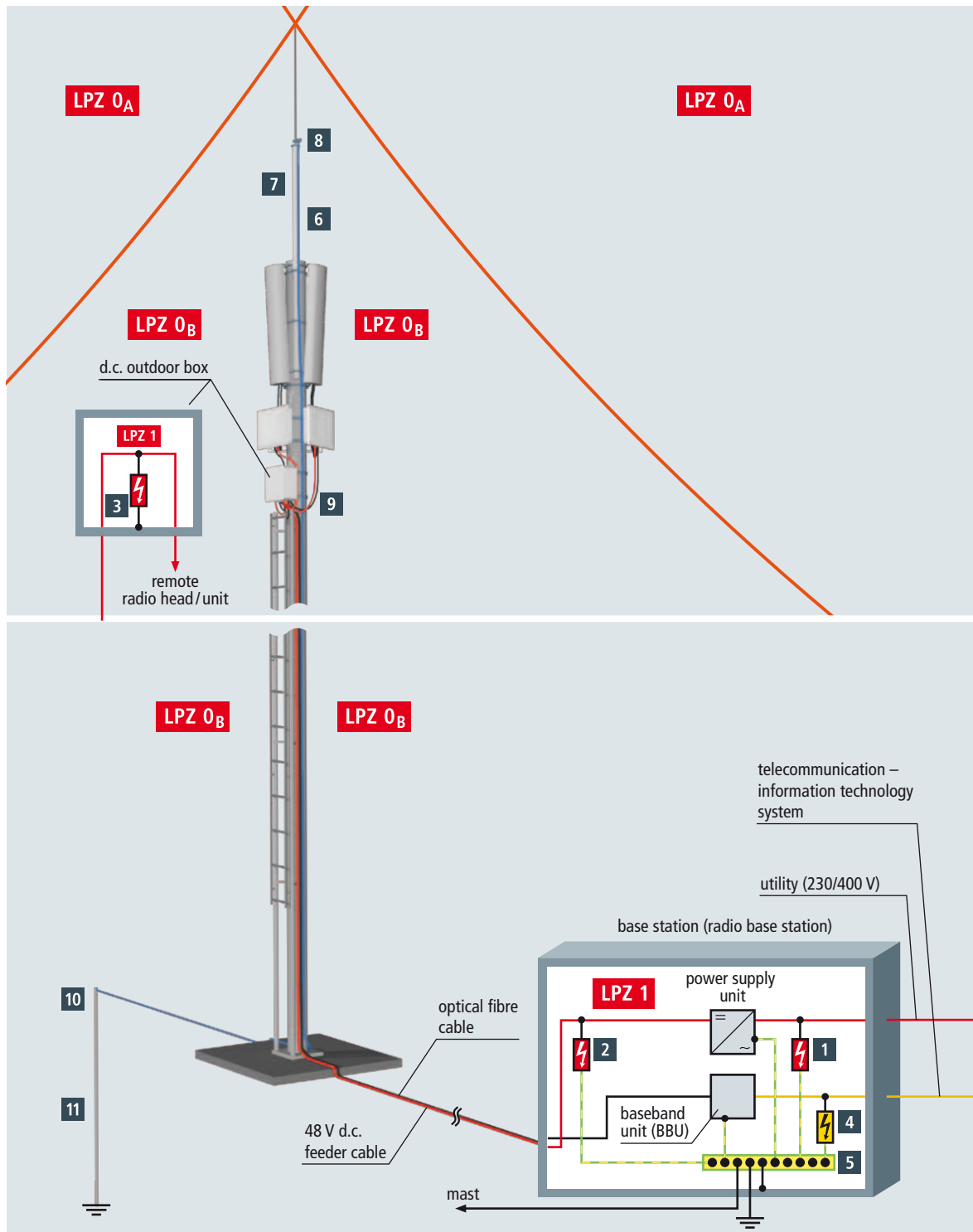

Figure 3 Remote radio head/unit and radio base station (RBS) in case of a ground-mounted mast



| No. in Fig. 3                        | Protection                           | Type  | Part No.           |
|--------------------------------------|--------------------------------------|---|--------------------|
| <b>a.c. power supply</b>             |                                      |   |                    |
| <b>1</b>                             | 230/400 V a.c. base station          | DEHNvap CSP 3P 100 FM                               | 900 360            |
| <b>d.c. power supply</b>             |                                      |   |                    |
| <b>2</b>                             | 48 V d.c. power supply unit          | DEHNsecure DSE M 1 60 FM                            | 971 126            |
| <b>3</b>                             | 48 V d.c. remote radio head          | DEHNsecure DSE M 2P 60 FM                           | 971 226            |
| <b>Landline connection</b>           |                                      |   |                    |
| <b>4</b>                             | Telecommunication lines              | BLITZDUCTOR XT BXT ML4 B 180<br>+ BXT BAS base part | 920 310<br>920 300 |
| <b>External lightning protection</b> |                                      |   |                    |
| <b>5</b>                             | Ground-mounted / roof-mounted system | Equipotential bonding bar, 10 terminals             | 472 219            |
| <b>6</b>                             | Ground-mounted / roof-mounted system | HVI Conductor III                                   | 819 025            |
| <b>7</b>                             | Ground-mounted / roof-mounted system | GRP/Al supporting tube                              | 105 306            |
| <b>8</b>                             | Ground-mounted / roof-mounted system | Terminal plate                                      | 301 339            |
| <b>9</b>                             | Ground-mounted / roof-mounted system | Pipe clamp for antennas                             | 540 100            |
| <b>10</b>                            | Ground-mounted system                | Stainless steel terminal bracket                    | 620 915            |
| <b>11</b>                            | Ground-mounted system                | Stainless steel earth rod                           | 620 902            |

Table 1 Lightning and surge protection for cell sites

power supply units and remote radio heads/units, lightning currents are prevented from entering system technology, thus providing maximum protection and ensuring availability of the station even under lightning conditions (Figures 2 and 3).

### Customised solutions for 48 V d.c. remote radio heads/units (type 1 arresters)

#### d.c. arresters: Modular type 1 lightning current arresters, DEHNsecure 60 ... (FM)

RRHs/RRUs are centrally supplied with direct current from the service room. The shielded feeder cable is to be integrated in the earth-termination system as per IEC 60728-11 and, if a lightning protection system is installed on the building, as per EN/IEC 62305 Part 3.

Type 1 d.c. arresters with a low voltage protection level that are specifically designed for RRH/RRU applications are installed in the d.c. indoor box near the power supply unit in the technical room and in the d.c. outdoor box at the antenna mast. The d.c. box at the mast features a "1+1" circuit, meaning that the positive pole and cable shield are interconnected

indirectly via a so-called total spark gap to prevent corrosion and stray currents. In the power supply unit the positive pole is directly earthed and single-pole type 1 d.c. arresters are typically installed.

Prewired d.c. assembly systems (d.c. box) for indoor and outdoor installation with DEHNsecure DSE M 1 60 FM and DSE 2P 60 FM type 1 d.c. lightning current arresters ensure efficient system protection. The voltage protection level  $U_p$  of the type 1 lightning current arresters must be lower than the dielectric strength of the system technology.

The new d.c. arrester concept provides various benefits, for example enough leeway for future extensions of the site in case of nominal load currents up to 2000 A, no mains follow currents up to max. 60 V d.c., no leakage currents and a high degree of protection for terminal equipment due to the low residual voltage of  $\leq 0.4$  kV at 5 kA (voltage protection level of 1.5 kV (10/350  $\mu$ s)).

Figure 4 shows the protection concept for a RRH/RRU application in case of physically separated functional equipotential bonding levels.



# White paper

## Protection of mobile cell sites (4G / LTE)

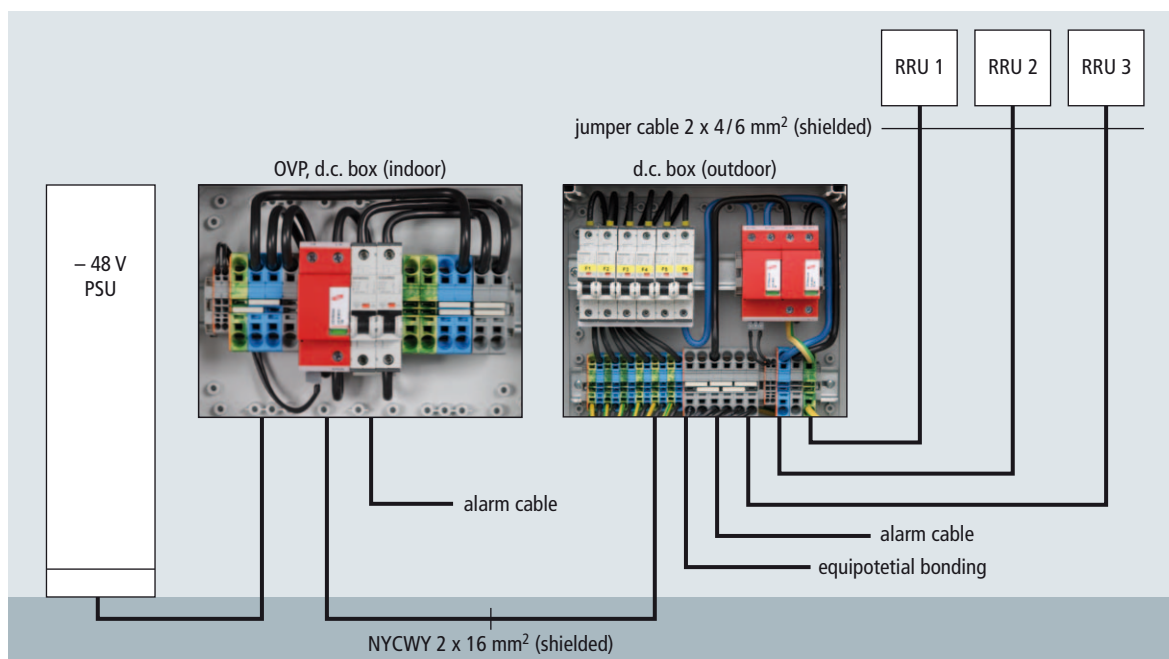

Figure 4 Basic circuit diagram of remote radio heads (RRHs) in case of physically separated functional equipotential bonding levels with d.c. box (outdoor) and DEHNsecure DSE M 2P 60 FM as well as OVP box (indoor) and DEHNsecure DSE M 1 60 FM

### Type 1 combined arresters for protecting RRHs/RRUs

Figure 5 shows a customised assembly system with a spark-gap-based arrester (type 1 arrester according to IEC 61643-1/11).

The space-saving DEHNshield arrester with a width of only two modules has a maximum discharge capacity of 12.5 kA per pole (10/350  $\mu$ s) and a voltage protection level  $U_p$  of 1.5 kV and is thus ideally suited for protecting terminal equipment. This assembly system allows to supply up to six RRHs/RRUs with 48 V d.c. (max. 60 V and max. 80 A) via glass fibre cables for data communication. Moreover, the design of the d.c. box ensures an extremely low wind load and easy installation on the mast.

### Customised solutions for 48 V d.c. remote radio heads/units (type 2 arresters)

Depending on the protection philosophy of mobile network operators and system manufacturers, technical specifications and country-specific conditions, type 2 assembly systems according to EN 61439-1/-2 are also used. Varistor-based type 2 arresters with an extremely low voltage protection level such as DEHNguard DG S 75 FM protect terminal equipment and are used for RRHs/RRUs with a nominal voltage up to 48 V d.c. Figure 6 shows a prewired type 2 assembly system in the form of a hybrid box (d.c. box) for indoor and outdoor installation.

The lockable glass fibre reinforced (GRP) enclosure with IP 66 degree of protection provides space for up to and including six RRHs/RRUs. All incoming and outgoing cables up to 48 V d.c. are wired on terminal blocks. This provides significant installation benefits for the installer, in particular for mast installation and retrofitting. For data communication, the d.c. hybrid box houses up to 12 LC Duplex adapters that accept the prewired glass fibre cable from the technical room. These adapters are connected to the RRHs/RRUs via so-called jumper cables by the most direct path. Easy-to-install accessory such as wall brackets and mast brackets with tensioning strap ensure easy and fast installation.

### Comparison of the protective effects of spark-gap-based and varistor-based type 1 arresters

A so-called "wave breaker function" is achieved by the fast triggering of the spark gap within a matter of microseconds, meaning that almost no current flows into the terminal equipment to be protected after the spark gap has ignited (Figure 7).

Thus, a relatively small amount of energy enters the terminal equipment even in case of extremely high impulse currents. This energy, however, is uncritical for the protective circuit integrated in the input of the terminal equipment.

If MOV solutions are used, the current flows into the terminal equipment to be protected over the entire impulse duration. In

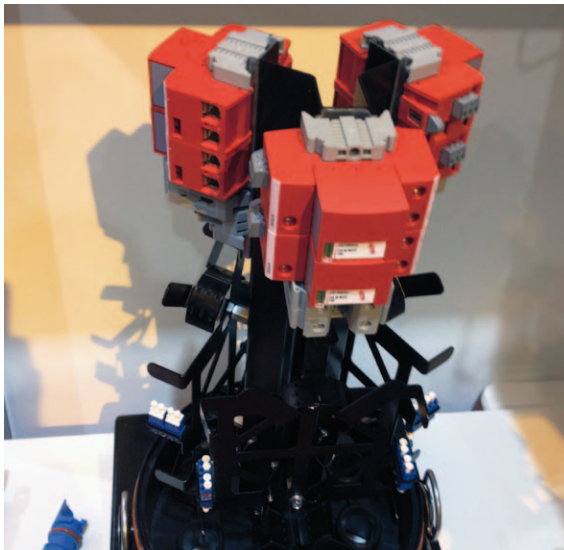

Figure 5 RRH installation protected by type 1 arresters in a typical installation environment

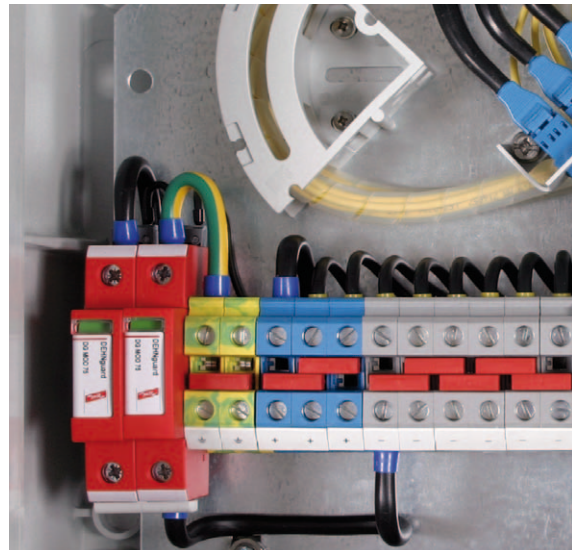

Figure 6 Prewired hybrid box for 48 V d.c. outdoor installations with DEHNgard type 2 arrester

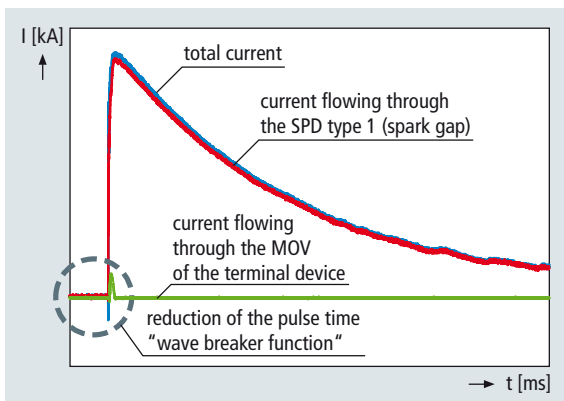

Figure 7 Spark-gap-based type 1 SPD (typical characteristic curve)

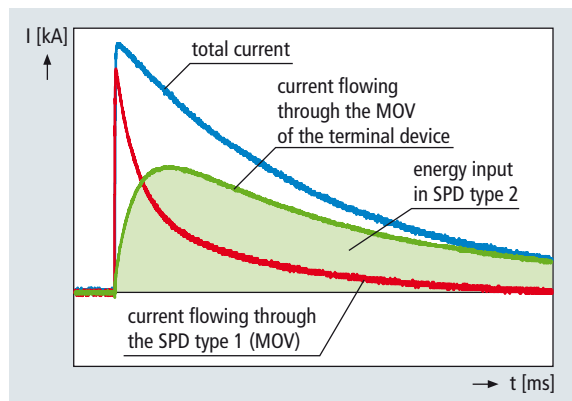

Figure 8 Varistor-based type 1 SPD (typical characteristic curve)

many cases, the connected a.c./d.c. power supply unit and system technology are damaged and in the worst case completely destroyed (Figure 8).

System tests with mobile radio equipment from different manufacturers clearly show that only spark gaps ensure the required degree of protection in this field of application.

**Surge Protection  
Lightning Protection  
Safety Equipment  
DEHN protects.**

DEHN + SÖHNE  
GmbH + Co.KG.

Hans-Dehn-Str. 1  
Postfach 1640  
92306 Neumarkt  
Germany

Tel. +49 9181 906-0  
Fax +49 9181 906-1100  
info@dehn.de  
www.dehn.de

Type designations of products mentioned in the white paper being at the same time registered trademarks are not especially marked. So if there is no marking of <sup>TM</sup> or <sup>®</sup> this does not mean that the type designation is a free trade name. Neither it can be seen whether patents or utility models and other intellectual and industrial property rights are available. We reserve the right to introduce changes in performance, configuration and technology, dimensions, weights and materials in the course of technical progress. The figures are shown without obligation. Misprints, errors and modifications excepted. Reproduction in any form whatsoever is forbidden without our authorisation.

actiVsense, BLITZDUCTOR, BLITZPLANER, DEHN, DEHN Logo, DEHNbloc, DEHNfix, DEHNgrip, DEHNguard, DEHNport, DEHNQUICK, DEHNrapid, DEHNshield, DEHNsnap, DEHNventil, HVI, LifeCheck, Red/Line, Yellow/Line are protected by German Trade Mark, by Community Trade Mark (EU) and/or in other countries.